











# MANUAL COMBIMAGNETRON FORCED AIR– IKEA SMAKSAK

**ATTENTION, BEFORE USING THE COMBI MICROWAVE PLEASE READ THE FOLLOWING CAREFULLY!! THIS IS TO USE THE ACCESSORIES (GLASS PLATE, WIRE RACK AND BAKING TRAY) CORRECTLY !!**

**READ THE FOLLOWING PAGES CAREFULLY!!**

Heating function	Application	
 Off position	The oven is off.	
 Forced Air Cooking	To bake on up to two shelf positions at the same time and to dry food. Set the temperature 20 - 40 °C lower than for Conventional (Top and Bottom Heat).	Only use baking tray or wire rack DO NOT USE A GLASS BOTTOM PLATE!!!
 Conventional (Top and Bottom Heat)	To bake and roast food on one shelf position.	Only use baking tray or wire rack DO NOT USE A GLASS BOTTOM PLATE!!!
 Grilling	To grill food in medium quantities in the middle of the shelf. To make toasts.	Only use the Grid DO NOT USE A BAKING TRAY OR A GLASS BASE PLATE!!!
 True Fan Cooking + MW	Microwave Combi - function with MW boost that accelerates cooking. To bake on one shelf position. Do not preheat the oven.	DO NOT USE A GLASS BASE TRAY, GRID OR BAKING TRAY!!!
 Conventional Cooking + MW	Microwave Combi - function with MW boost that accelerates cooking. To bake and roast food on one shelf position. Do not preheat the oven.	DO NOT USE A GLASS BASE TRAY, GRID OR BAKING TRAY!!!
 Grill + MW	Microwave Combi - function with MW boost that accelerates cooking. To grill flat food and to toast bread. Do not preheat the oven.	DO NOT USE A GLASS BASE TRAY, GRID OR BAKING TRAY!!!
 Microwave	Microwave function (100 - 1000 W). Creates the heat directly in the food. To heat pre-prepared meals and drinks, to defrost meat or fruit, and to cook vegetables and fish. Do not preheat the oven.	Only use Glass bottom plate DO NOT USE A BAKING TRAY OR RACK!!!
 Liquids	Microwave function at high power (800 - 1000 W). To heat drinks. Creates the heat directly in the food. Do not preheat the oven.	Only use Glass bottom plate DO NOT USE A BAKING TRAY OR RACK!!!
 Defrost	Microwave function at low power (100 - 200 W). To defrost meat, fish, bread, fruit and vegetables. Creates the heat directly in the food. Do not preheat the oven.	Only use Glass bottom plate DO NOT USE A BAKING TRAY OR RACK!!!
 Reheating	Microwave function at medium power (300 - 700 W). To heat pre-prepared meals. Creates the heat directly in the food. Do not preheat the oven.	Only use Glass bottom plate DO NOT USE A BAKING TRAY OR RACK!!!

**Wire shelf:**

Push the shelf between the guide bars of the shelf support and make sure that the feet point down.

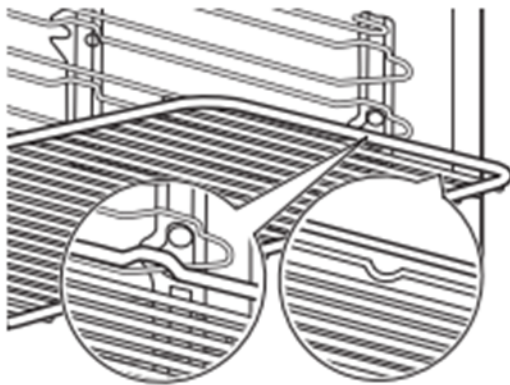

**Baking tray:**

Push the baking tray between the guide bars of the shelf support.



**Microwave bottom glass plate:**

**⚠ Caution!** Use the microwave bottom glass plate only with microwave function. Remove the accessory when you switch to another function e.g. microwave grilling or grilling.

Put the accessory on the bottom of the cavity. Put the food on the microwave bottom glass plate.

Always use the microwave bottom glass plate when the microwave function is on. It is necessary for heating food or liquids.

**⚠ Warning!** The microwave bottom glass plate can become hot when the oven operates.

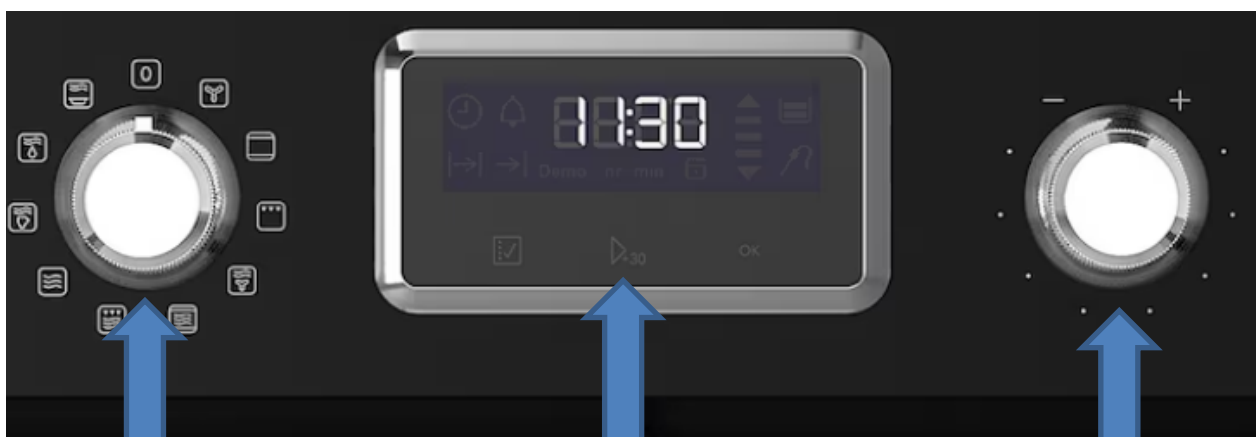
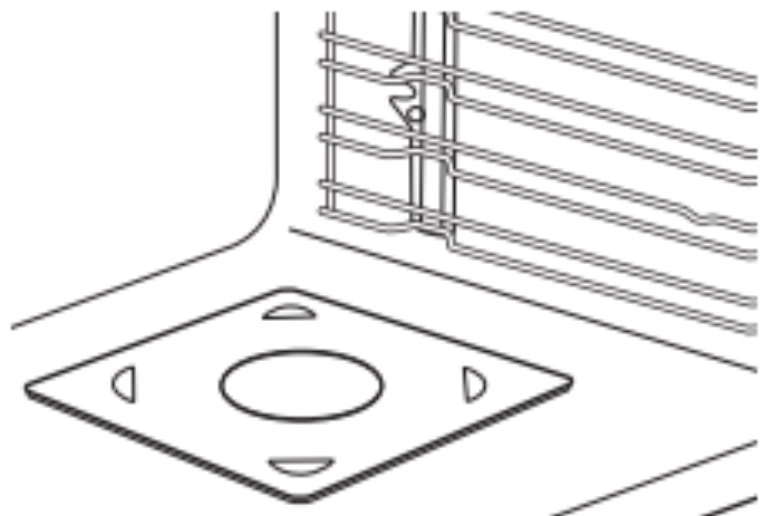



Heating function button

Temperature (oven) / Control knob

Sensor field / Button	Function	Description
	OPTIONS	To set the clock functions, microwave power. To check the oven temperature. Use only while a heating function operates.
	START + 30sec	To start a heating function. Press to extend Microwave function duration for 30 seconds.
OK	OK	To confirm.

### Set the microwave function:

1. Remove all accessories.
2. Place the microwave bottom glass plate.
3. Turn the heating function knob to select a function: .

 **NB! Never operate the oven without food inside.**

Press  to start with the default settings.

4. Keep pressing  to toggle between the settings for: Duration and microwave power.

Turn the control knob to set the value and press **OK** to confirm.

You can also press  to change Duration in 30 second increments.

When the time set for Duration ends, the audible signal sounds again and the oven stops.

5. Turn the knob for the heating functions to the off position to switch off the oven.

If you open the oven door, the oven will stop. To restart it, close the door and press .

### To set the Combination microwave function:

1. Remove the glass base, baking tray and rack from the microwave.
2. Turn the knob for the heating functions  to select the function.

 **NB! Never operate the oven without food inside.**

The standard temperature appears in the display.

3. Press  to start.

4. Press  again and again to change: Duration, microwave power, temperature.

Turn the control knob to set the value and press **OK** to confirm.

An audible signal sounds about 5 degrees before the set temperature is reached.



When the set time ends, the audible signal sounds again and the oven stops.

5. Turn the knob for the heating functions to the off position.

When you use this function with the set time more than 7 minutes, the microwave power cannot exceed 600 W.



 The oven may make noises when using the Combination Microwave function.

### Setting the oven function:

1. Remove the glass bottom plate ,
2. Place the baking tray and/or grille   or just the grille .
3. Turn the heating function knob to select one of the above (2.) functions.
4. Turn the control knob to set the temperature.

5. Press  to start.

6. Turn the knob for the heating functions to the off position to switch off the oven.

 **When the oven function is active, the bars in the display  appear one by one when the temperature inside the oven rises and disappear when the temperature falls.**